

PUMP MODEL	TRA10-0600
ORIENTATION	VERTICAL
COVER	STANDARD
INLET	2.5" TRI-CLAMP
DISCHARGE	2.5" TRI-CLAMP
SPECIALS	NONE

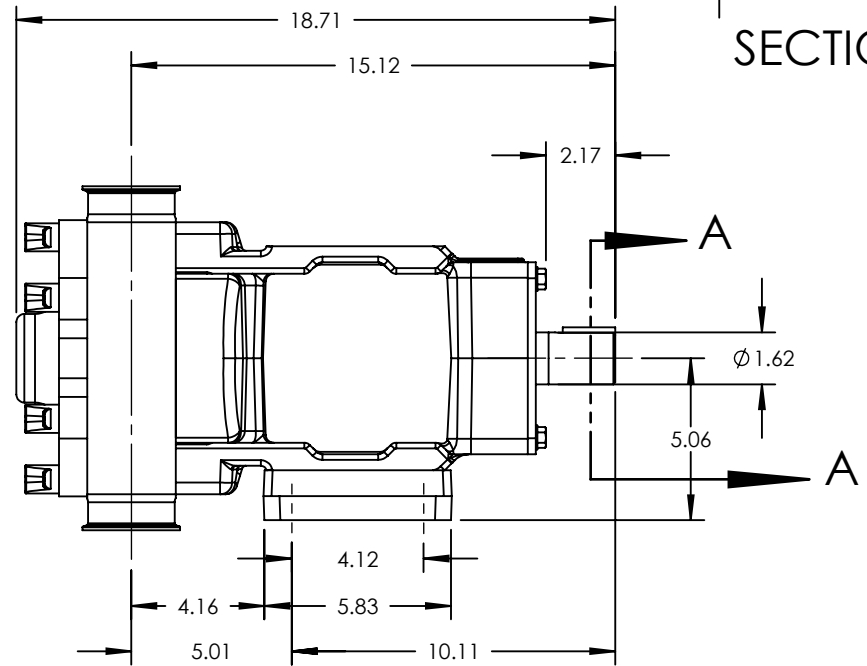

NOTES:
1. THIS IS NOT A CERTIFIED DRAWING. USE FOR GENERAL INSTALLATION ONLY.

STATE	Released	08/12/2013	DIMENSIONS ARE IN INCHES
DRAWN	cneff	8/9/2013	
CHECKED	MPS	08/09/2013	
PROJECT:			WAS:

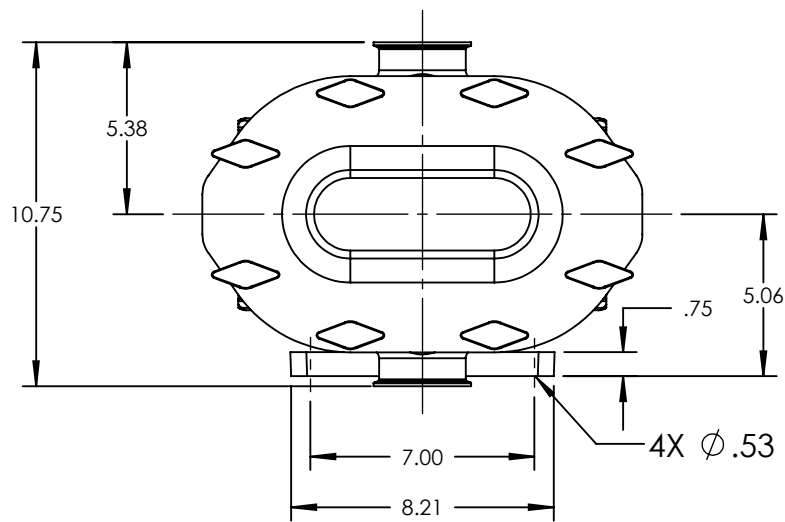
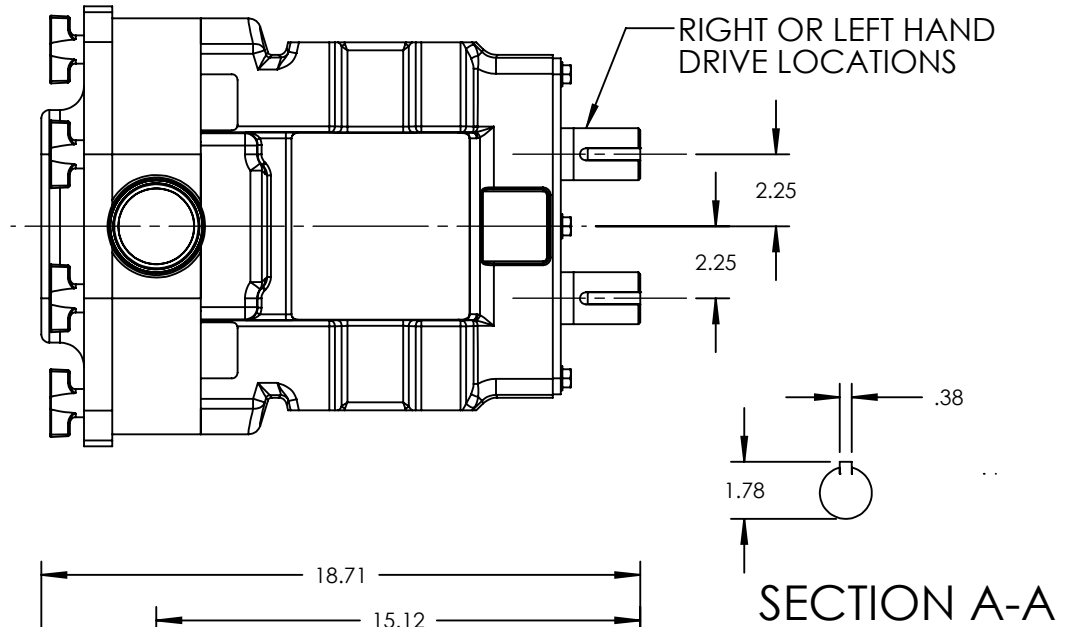

THIS DRAWING IS THE PROPERTY OF WRIGHTFLOW TECHNOLOGIES AND IS PROPRIETARY IN GENERAL AND DETAIL. IT SHALL NOT BE COPIED OR ITS CONTENTS REVEALED TO OUTSIDE PARTIES WITHOUT THE WRITTEN CONSENT OF WRIGHTFLOW TECHNOLOGIES

3D

DWG. NO. TRA10-0600-002
SHEET 1 OF 2

REV. B.0
08/12/2013