

PUMP MODEL	TRA20-0600
ORIENTATION	HORIZONTAL
COVER	STANDARD
INLET	2.5" TRI-CLAMP
DISCHARGE	2.5" TRI-CLAMP
SPECIALS	NONE

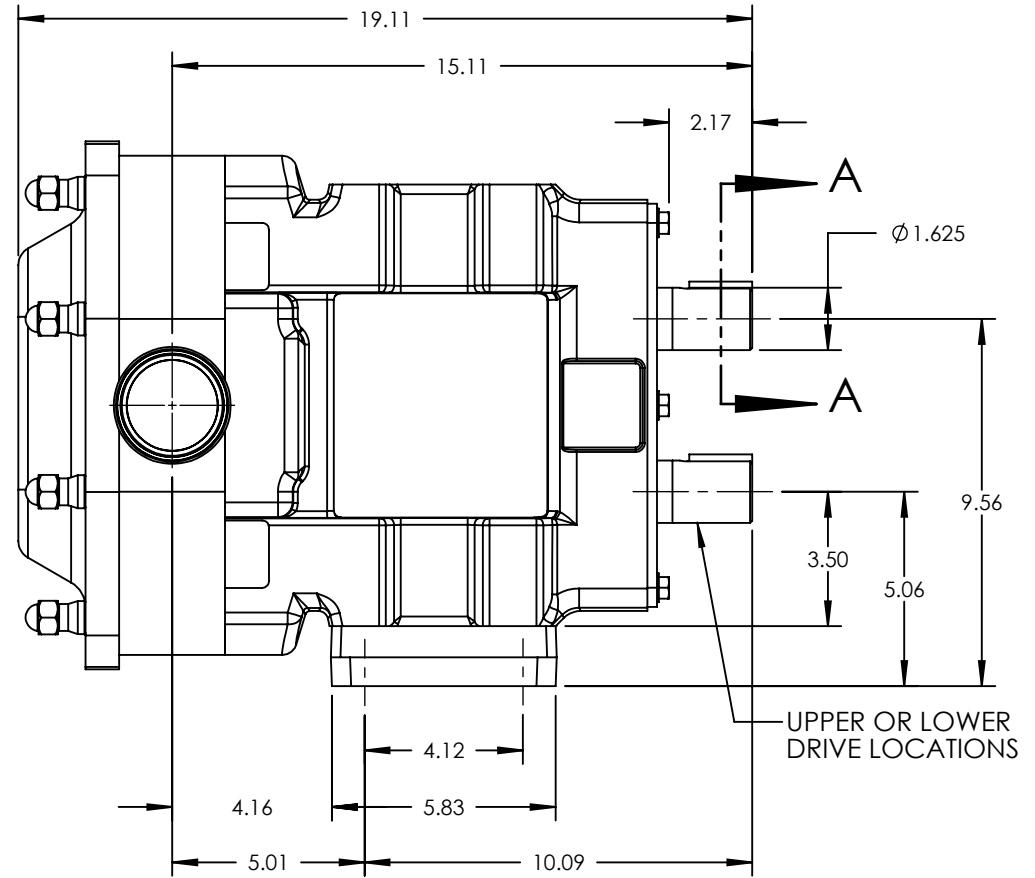
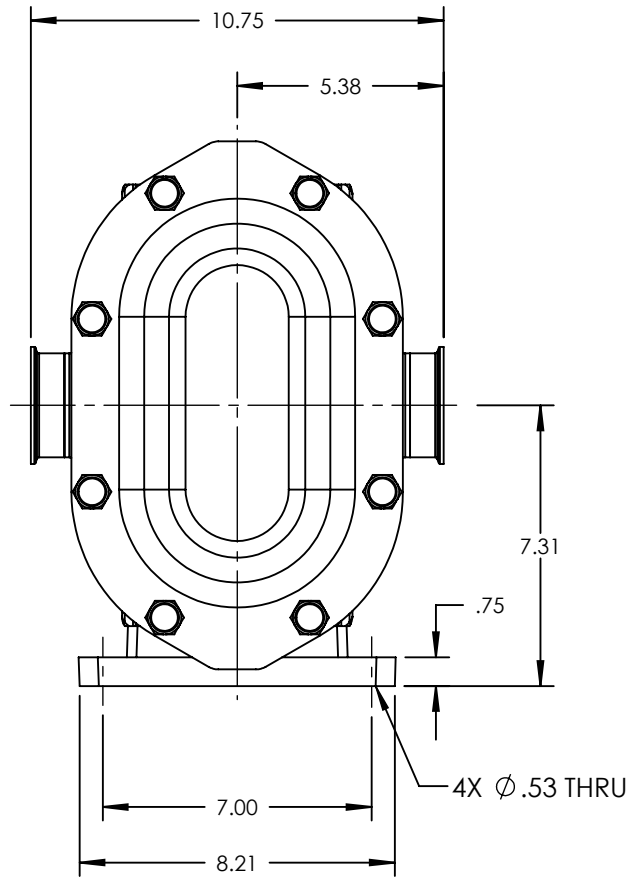
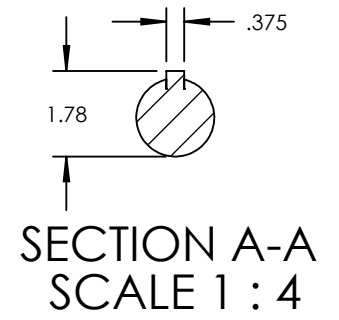

NOTES:
1. THIS IS NOT A CERTIFIED DRAWING. USE FOR GENERAL INSTALLATION ONLY.

STATE	Released	12/17/2013	DIMENSIONS ARE IN INCHES		<small>Wrightflow Technologies, A Unit of IDEX Corporation Cedar Falls, IA 50613 U.S.A. Eastborne, East Sussex, BN23 6PT UK</small>	<small>THIS DRAWING IS THE PROPERTY OF WRIGHTFLOW TECHNOLOGIES AND IS PROPRIETARY IN GENERAL AND DETAIL. IT SHALL NOT BE COPIED OR ITS CONTENTS REVEALED TO OUTSIDE PARTIES WITHOUT THE WRITTEN CONSENT OF WRIGHTFLOW TECHNOLOGIES</small>	3D	DWG. NO.	SHEET 1 OF 2	REV. C.0
DRAWN	cneff	12/3/2013						PROJECT:	TRA20-0600-001	12/03/2013
CHECKED	MPS	12/14/2013	WAS:							